

Haier Biomedical

Small Vacuum Freeze Dryer for Laboratory Use Operation Manual



Certificate of Quality

checker:

Model
DG-65Z04-10A
DG-65Z04-10AR
DG-65Z04-12AR
DG-65Z04-18AR
DG-86Z04-10AR



Manufacturer:
Qingdao Haier Biomedical Co., Ltd.
Address:
No. 280 Fengyuan Road, High-tech Zone, Qingdao,
266111 Shandong, P.R. China
Web: www.haiermedical.com
Revision Date: 06/2023
Version: 2th, 2023
Dedicated code: 027050
V13026

Haier Biomedical
Makes Life Better

- Please read through this Manual carefully before use.
- The explanation of this Manual lies with the Company.
- Keep this Manual with your invoice properly after read it.
- Any technologies or software may be upgraded without prior notice.
- The product appearance depends on the actual product.
- This product needs to be operated by professionals and may cause risks if used for household purposes.

Contents

Overview	1
Safety Precautions.....	2
Precautions for product use.....	4
Features and technical indicators	6
Operating conditions.....	7
Instrument installation and freeze-drying preparation	8
System settings	12
Common faults and troubleshooting.....	26
Packing List	27

Packing List

DG-65Z04-10A Packing list

S/N	Name	Quantity	Remarks
1	Main body	1	
2	Vacuum pump	1	
3	Oil mist filter	1	
4	Mini-adjustable valve	1	Optional
5	15' KF clamp	1	Including a seal ring
6	25' KF clamp	2	Including a seal ring
7	Vacuum pumping pipe	1	
8	Power cord	1	
9	200mm material tray	3	
10	Product manual	1	

DG-65Z04-10/12/18ARPacking list

S/N	Name	Quantity	Remarks
1	Main body	1	
2	Material rack	1	Drying rack and pre-freezing rack
3	Material rack holder	1	
4	Drying cylinder	1	
5	Vacuum pump	1	
6	Mini-adjustable valve	1	Optional
7	15' KF clamp	1	Including a seal ring
8	25' KF clamp	2	Including a seal ring
9	Vacuum pumping pipe	1	
10	Power cord	1	
11	200mm material tray	3	10AR: 3 pcs; 12AR: 4 pcs; 18AR: 6 pcs
12	Plugging component	1	Optional; drying cylinder and plugging device
13	Multi-manifold assembly	1	Optional; drying cylinder, freeze-drying bottle *8, and three-way valve *8
14	Product manual	1	

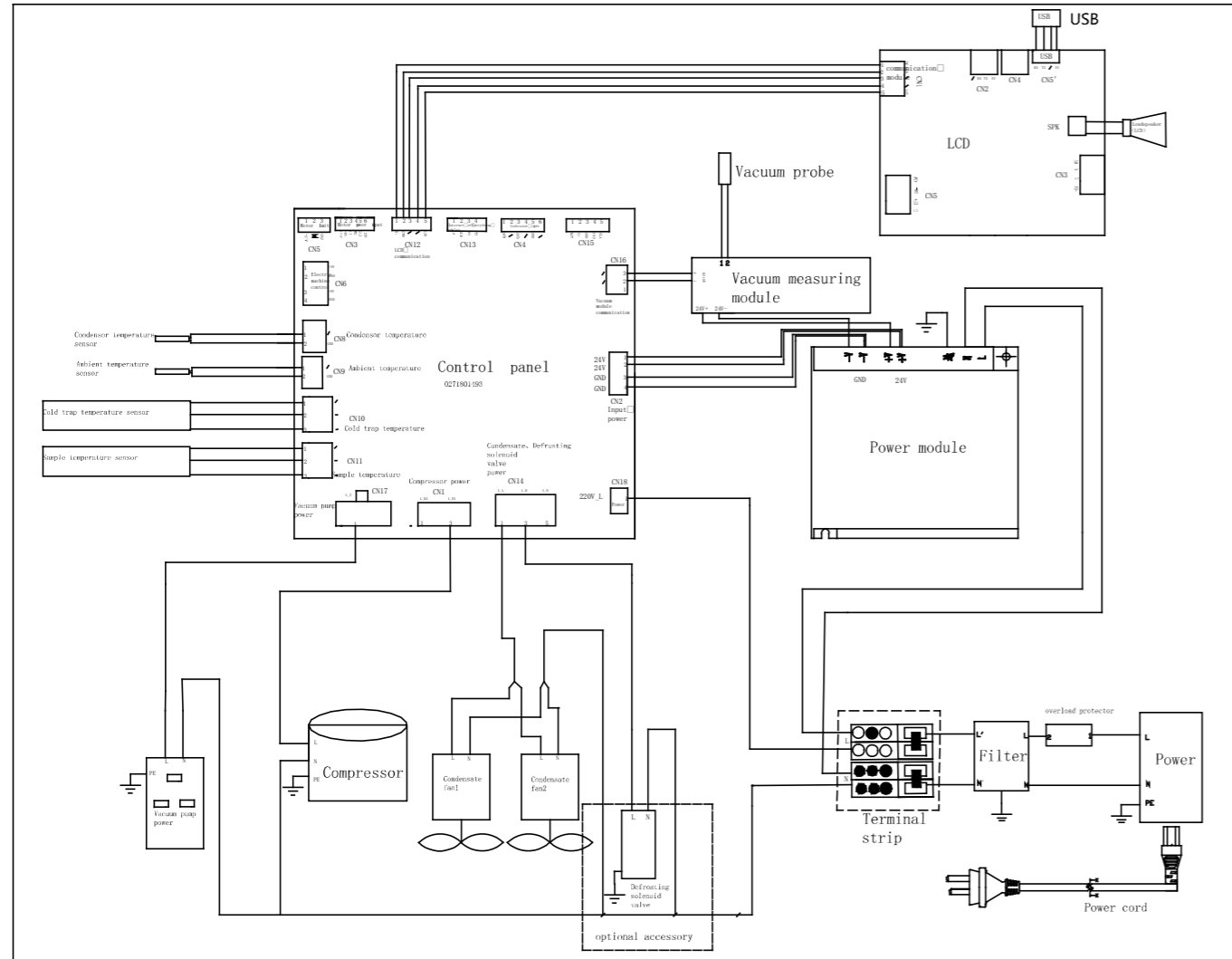

Overview

The vacuum freeze-drying technology, also known as sublimation drying, is a method of pre-freezing water-containing samples into solids and then sublimating the water from the solids in the vacuum state. After being freeze-dried, the articles can maintain their original biological, chemical, and physical properties basically unchanged and can be preserved for a long time. When water is added, the articles can restore to the state before freeze-drying while maintaining the original biochemical properties. Therefore, the freeze-drying technology has gained extensive applications in various fields, including pharmaceutical, food, chemical, biological products, etc.

The small vacuum freeze dryer for laboratory use is available in four configurations:

- Standard configuration: Ordinary drying configuration—Samples are pre-frozen and dried in sample trays.
- Optional: Capping configuration: The vials containing samples are pre-frozen and dried. After drying, the caps are firmly closed in vacuum state by manual operations, which is equivalent to vacuum packaging;
- Optional: Multi-manifold drying configuration: After the samples are pre-frozen in the special bottles, they are connected to the freeze-drying cover through the rubber valve. During freeze drying, the freeze-drying bottle can be changed through valve opening and closing whenever necessary, and different kinds of samples can be freeze-dried simultaneously. In actual operation, eight special bottles of different capacities can be used at the same time, thus improving the drying efficiency;
- Optional: Multi-manifold capping drying configuration: the freeze-drying cover is capable of freeze drying the samples contained in the vials and capping, and it can also hang bottles for drying, thus improving the freeze drying efficiency.
- Pre-freezing function: Stainless-steel trays containing samples are placed on the material racks; then, the shelves are dropped down into the cold trap for pre-freezing and then for drying after the pre-freezing is completed. The pre-freezing function reduces the risk of the stored samples thawing due to frequent opening of the ultra-low temperature freezer for pre-freezing.

Safety Precautions

Dear Haier users,
Thanks for choosing Haier vacuum freeze dryer. For a better understanding of this manual and better use of the product to avoid injuries to personnel and damage to the product, please read the manual carefully and observe the contents marked with the following signs in this manual.

Safety labels



Safety Precautions

Warning Whenever the sign appears, it is necessary to refer to the instructions to confirm any potential risks and any countermeasures to be taken.

Warning Failure to observe the instructions or requirements marked with this sign may lead to serious injuries or death.

Caution Failure to observe the matters under the caution signs may cause casualties or damage to the incubator and associated property loss.

Actions or operations that must be prohibited

Actions or operating procedures that must be taken or followed

- When there is any leakage of flammable gas, such as coal gas, shut off the feed valve of the gas. Open windows for ventilation or exhaust. Do not plug in or unplug your product as the spark in these processes can cause an explosion or fire;
- Only professional technicians or after-sales maintenance personnel can install the product, or it may cause electric shock or fire.
- Make sure to place the product firmly on solid and flat ground. If the ground is not solid or the product is placed in an improper place, it will cause the product to turn over or any person to be injured;
- Please use the special power supply indicated on the nameplate of the product; otherwise, it may cause fire or electric shock.
- If the voltage used is lower than 198V or higher than 242V, an automatic voltage regulator with a capacity of 4000 W or higher, which is suitable for motor load, shall be installed.
- If the power cord needs to be extended, the extended cable must be no less than 2 mm² in the cross-section and no longer than 3m in length to avoid fire or electric shock.
- The power cord of the product is equipped with a three-wire (grounded) plug which matches with the standard three-wire (grounded) socket of 10A. The grounding pin of the power cord can be cut off or removed under no circumstances. Make sure that the power plug and socket are tightly and reliably connected; otherwise, a fire may be caused.
- The power socket intended for the product must be grounded to avoid electric shock.
- If the socket does not meet this requirement, the condition must be corrected by a qualified technician before use.
- Do not use the product outdoors. Electric leakage or shock may be caused if the product gets wet by rainwater.
- Do not place the product in a damp place or a place that is prone to be splashed by water, or it may lead to leakage or electric shock due to reduced insulation.
- Do not pour water directly onto the product, or it may cause an electric shock or short circuit;

Wiring diagram

DG-65Z04-10A

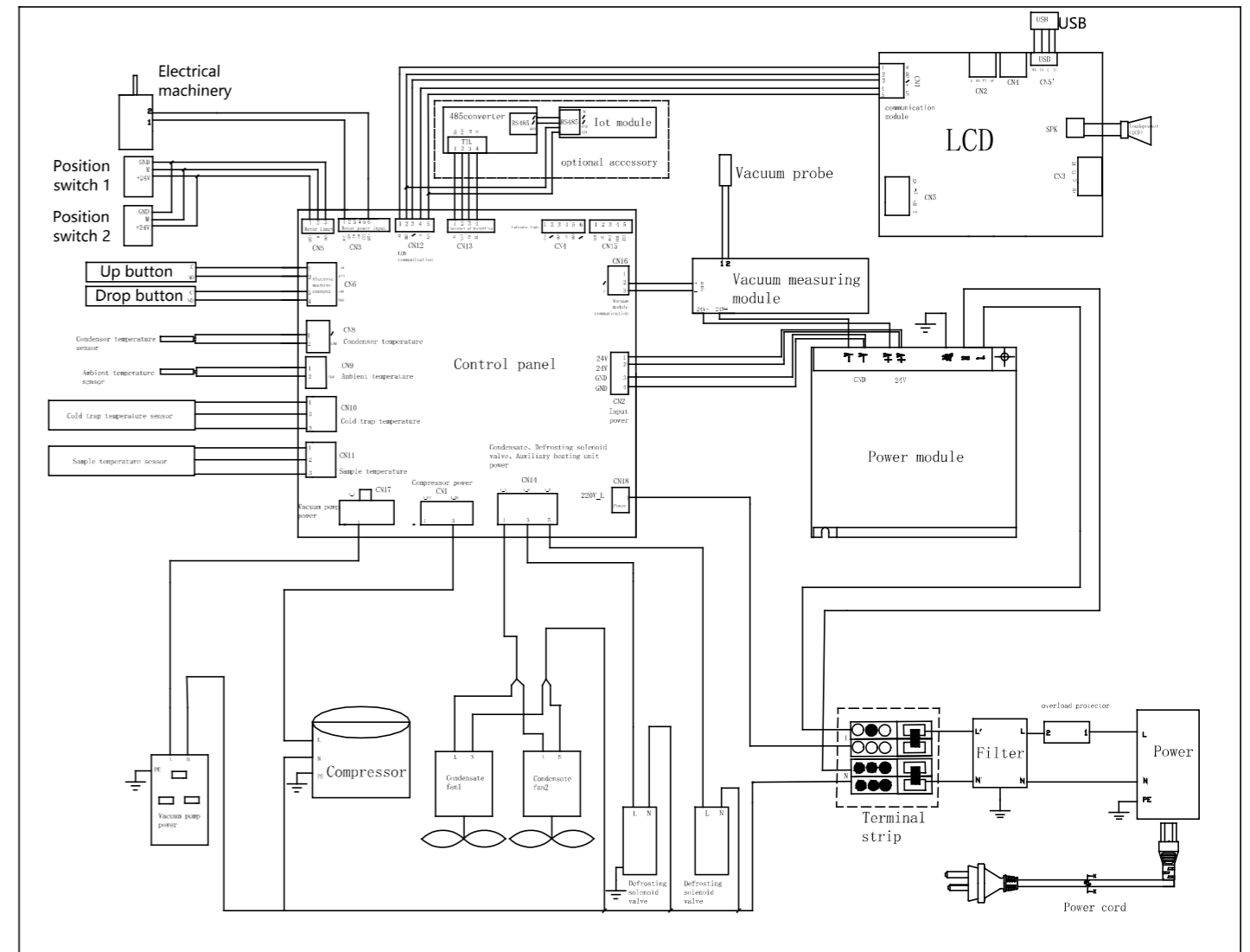

Common faults and troubleshooting

1. The vacuum degree cannot reach below 15 Pa
 - (1) Check the connection between the vacuum pump and the host and whether the clamp is properly fastened.
 - (2) Check whether the lower surface of the organic glass cover is clean and whether there is any damage.
 - (3) Check that the O-shaped seal ring is clean and placed correctly.
 - (4) Check whether the vacuum pump works properly and whether the pump oil is clean.
 - (5) Check that the vacuum valve is tightened.
2. The vacuum pump leaks oil
 - (1) Check the machine body, and replace the corresponding leaking part.
3. The cold trap temperature is too high
 - (1) The ambient temperature is too high, or the heat dissipation is poor. In this case, place the machine in a place with proper ambient temperature and good ventilation.
 - (2) If the refrigeration system fails, please contact the company's technical engineer.

- ⊘ Do not place any container filled with water or heavy object on the product. If an object falls, it may cause injury, and the water overflowing may reduce insulation and cause electric leakage or shock;
- ⊘ Do not ground the product through gas lines, water mains, telephone lines, or lightning rods as this may lead to electric shock or other dangers.
- ⊘ Do not touch any electrical components, switches or power plugs with wet hands. Such action may lead to electric shock.
- ! When unplugging the power cord from the socket, please grip the plug itself and pull it out. Do not pull the power cord as this may strip the wires out of the plug, thereby causing electric shock and fire.
- ! If the product is not operating properly, please disconnect the power plug. Keeping the combined refrigerator and freezer operating in an abnormal state may cause electric shock or fire.
- ⊘ The user shall not disassemble, repair or modify the product randomly; otherwise, fire or personal injury may be caused due to improper operation.
- ! Before performing any repair or maintenance for the product, be sure to disconnect the power supply to prevent any electric shock or injury.
- ! When repairing and maintaining the product, take precautions not to inhale any chemicals or aerosols floating inside and outside the unit. They might be harmful to your health.
- ! If poisonous, radioactive or other harmful materials need to be stored in the unit, the product should be located in a safe zone. Improper usage of the equipment with such materials may harm the environment or the operator's health.
- ! If the product is not in use for a long period of time, make sure the power cord is unplugged. Deteriorated insulation of the power cord may lead to electric shock, leakage, or fire.
- ! If the product is to be left unused in an unattended area for an extended period, ensure that children do not have access and that doors are not completely closed.
- ! The disposal of the product should be accomplished by the appropriate personnel. Remove doors to prevent accidents such as suffocation.
- ⊘ Do not place inflammable, explosive, dangerous, or volatile articles in the product, and do not use flammable sprays near the product; otherwise, it may cause an explosion or fire.
- ⊘ Do not freeze dry samples containing acid, alkali, or organic matters; otherwise, it may cause damage to the product components.
- ! Do not put plastic bags within reach of children as suffocation may be caused.
- ⊘ Do not climb on top of the product or place any object on it. Falling equipment may cause injury or property damage;
- ⊘ Do not insert metal objects, such as nails or wires, into any opening or gap on the product or into any vent for internal air circulation; otherwise, the objects mentioned above may contact moving parts and cause electric shock or injury.
- ! Pay attention to check the filter timely, and clean it if necessary. A dusty filter can lead to reduced cooling performance or failure of the product.
- ! During any repair operations, gloves should be worn to prevent getting injured by sharp edges or corners.
- ⊘ Do not touch the items directly with your hands. Touching frozen items or inner walls of the product may cause frostbite.
- ! Hold firmly onto the handle to close the door to avoid pinching your hands.
- ! Do not tilt the product more than 45 degrees when moving the unit.
- ! When handling the product, be careful not to trip over the product to prevent the device from being damaged or to prevent any person from being injured;
- ⊘ Do not attempt to use the handle to lift or move the product to avoid damaging the unit or injuring personnel.
- ! A C32A air switch with a leakage initiating current of 30mA shall be selected, and the wire (copper wire) diameter of the incoming and outgoing lines of the air switch shall be 4mm². An air switch is allowed to carry only one product.

Precautions for Use

During the normal process of use, please read the following precautions seriously before use, in order to keep the product in the best performance:

1. Precautions and prompts for the operating environment

- a) The vacuum pump shall be placed on the ground and maintains a certain height difference with the host. This is conducive to prevent the return of oil when there is a sudden power failure. In the case of any power failure, the air charging valve shall be screwed open immediately to charge the host, and the samples shall be taken out as soon as possible for proper storage.
- b) The operating ambient temperature shall be $\leq 32^{\circ}\text{C}$, and the humidity shall be $\leq 80\%$.
- c) When shutting down the equipment, you should charge air into the equipment first and then shut down the vacuum pump to prevent the return of the vacuum pump oil from contaminating the samples.
- d) The AR series drying cylinder shall be connected to the main body via an O-shaped seal ring.
- e) A grounded power socket shall be used. The seal ring shall be kept clean and shall not be scrubbed with organic solvents. The end of the drying cylinder coming in contact with the O-shaped seal ring should be protected from collision, scratch, and damage.
- f) According to the operation manual, the vacuum pump oil should be replaced regularly after 3 months of use, and attention shall be paid to maintenance (the specific situation depends on the pump oil level and color. If the liquid level drops significantly or the color becomes cloudy and yellow, it should be replaced immediately)
- g) Do not frequently switch on or off the power supply or the refrigerator. If the refrigerator stops due to operations, wait at least three minutes before restarting the refrigerator.
- h) The heat dissipation holes on both sides of the freeze dryer shall be cleaned regularly every 1-2 months.
- i) The vacuum pressure probe (vacuum gauge), the freeze-dried product temperature sensor, and the auxiliary heating unit are all wearing parts and are not covered by the warranty.

2. Operation prompts

- a) After opening the door, check whether there is any foreign matter or water in the cabinet. If so, please wipe it off with medical alcohol before starting the equipment. (Wipe the non-metal surfaces with a clean damp rag.)
- b) Select the program or custom program to be run; check whether the drain valve and mini-adjustable valve are closed first, and then click "Run"; then, the program will automatically run and display the running steps; to stop the program running, simply click the "Stop" button.
- c) To create a new program, customize the program parameters according to the requirements, and click Save to save the program.
- d) Make sure that the freeze-dried product temperature sensor is effectively immersed in the products freeze dried.
- e) Non professionals shall not operate the equipment at will to avoid unnecessary losses.
- f) The cold trap is used for ultra-low-temperature cooling. Wear gloves when handling it to prevent frostbite.
- g) The door of the drying chamber is made of brittle materials and shall be protected from collision of hard objects to avoid crushing and cuts.
- h) Do not lift or lower the material rack when the freezer dryer is in vacuum state (non-normal pressure).

Click the "Notepad" button to create a new notebook content and view the notebook records. For previous records, you can directly click them for modification and saving in the pop-up interface; when clicking "Delete", you can delete one or all messages.

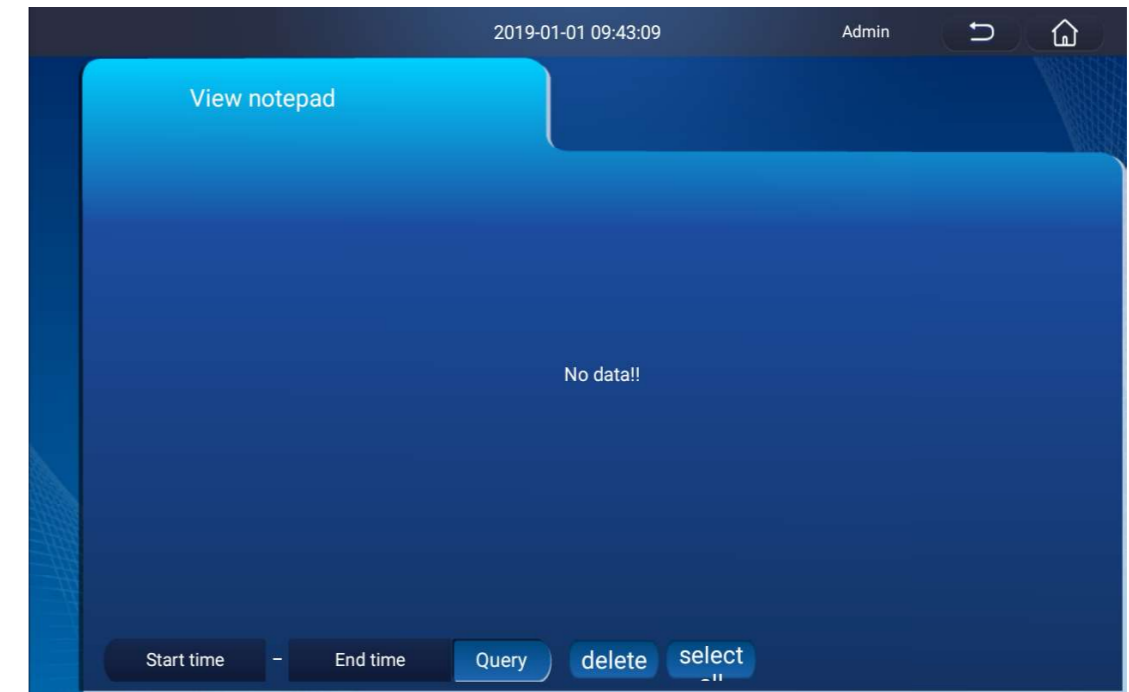

Click the "Announcement" button to view and publish the announcements.

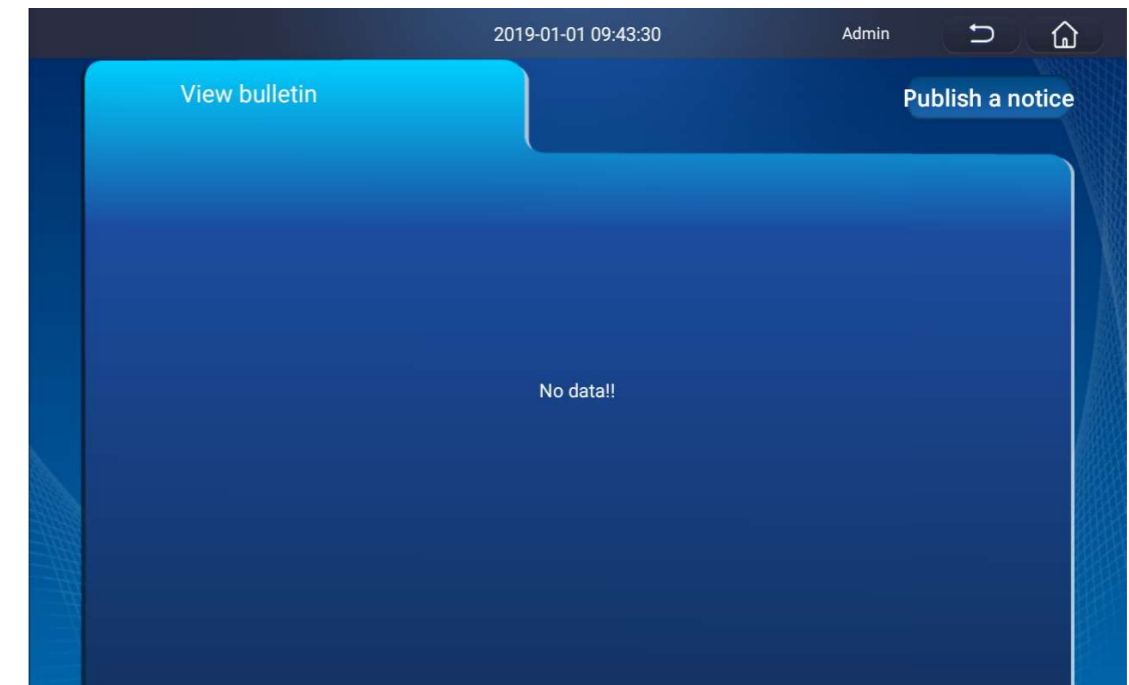

Click the "New Message" button to create a message. Select the user to be sent to (from among the users registered in the user settings) on the message interface, enter the title and content, and click "Send".

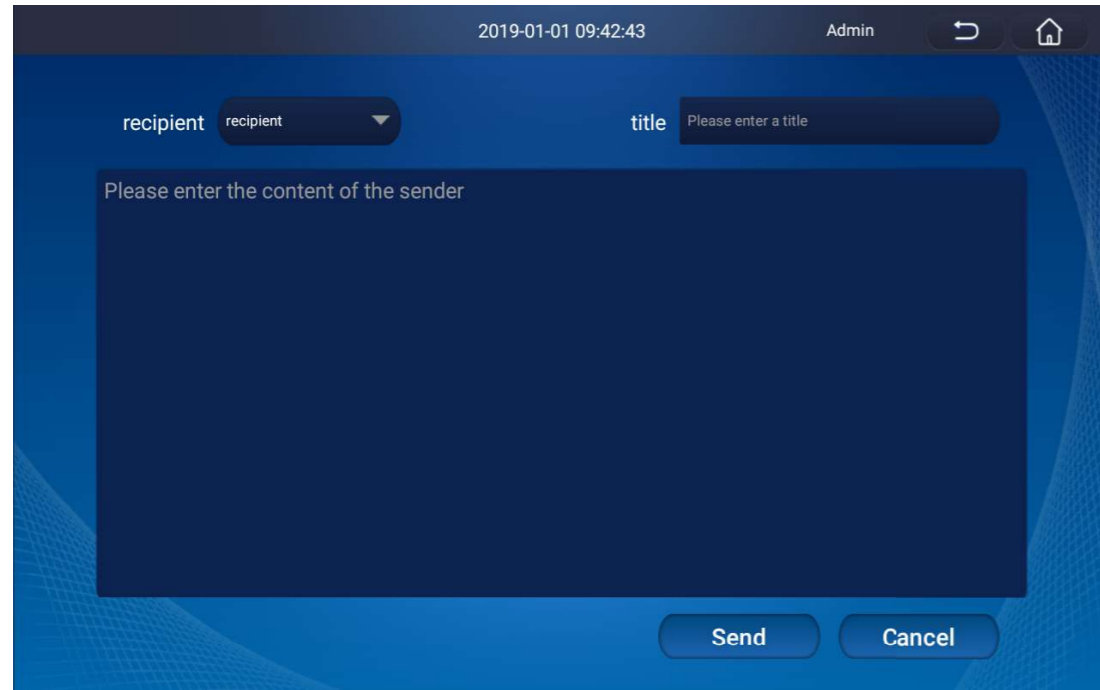

3. EMC description

Basic EMC performance claimed by the EMC tests: The refrigeration system operates properly to achieve cooling function for the temperature inside the freezer; the data recording system (if any) can work properly to achieve the data recording and transmission functions; the electronic door lock (if any) can work properly to achieve corresponding functions.

The alarm state shall be prompted in auditory and/or visual ways.

EMC requirements:

- a) The equipment conforms to the emission and immunity requirements stipulated in GB/T18268.1;
- b) The equipment is designed and tested as Class A equipment as set forth in GB4824. In the home environment, the equipment may cause radio interference, so protective measures need to be taken.
- c) It is recommended to evaluate the electromagnetic environment before using the equipment;
- d) It is prohibited to use the equipment in the surroundings of strong radiation sources (such as unshielded video sources). Otherwise, the normal operation of the equipment may be disturbed.

Click "Message Mailbox" to view the outbox and inbox records.

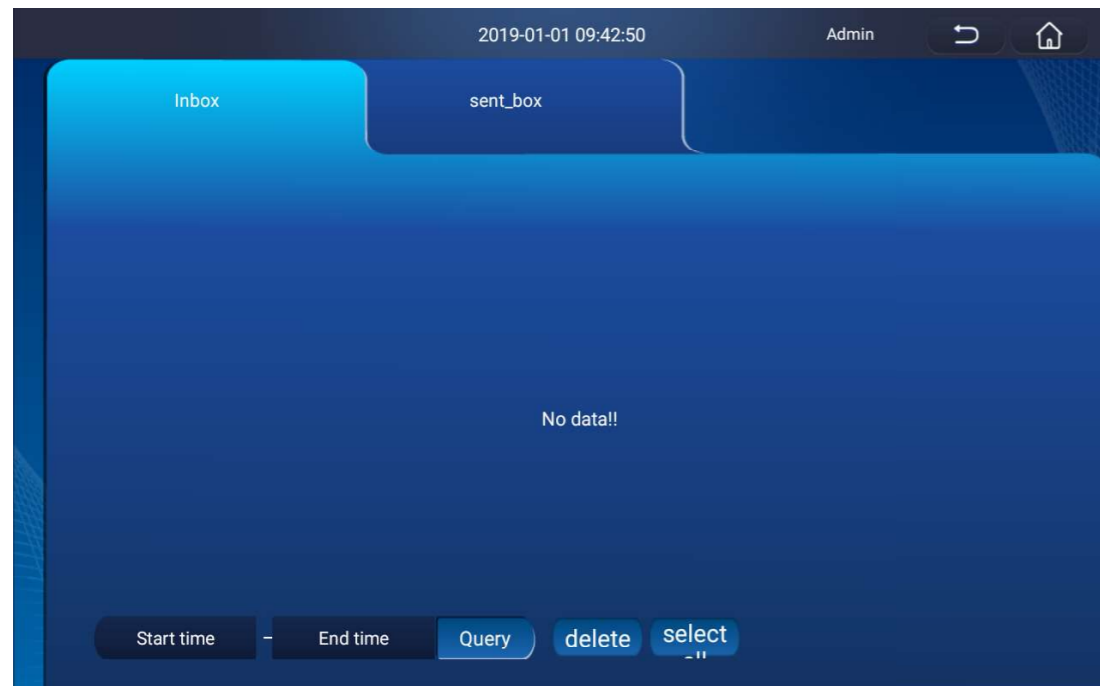

Features and technical indicators

Key features

1. Equipped with a SECOP compressor, the equipment delivers a high refrigeration efficiency and a fast cold trap cooling speed.
2. The LCD control system is easy to operate and powerful in functions.
3. The whole freeze-drying process can be fully automatically programmed and intelligently controlled to liberate the operator's hands (A series)
4. The control system can automatically save the freeze-drying data and display them in the form of curves, making the whole freeze-drying process clear at a glance.
5. The drying chamber is made of food-grade stainless steel and designed with a colorless transparent organic glass door (A series) or a colorless transparent organic glass cover (AR series), so the samples are clear and intuitive, and the whole process of freeze-drying can be observed.
6. The large-diameter cold trap and the built-in evaporator coil tubes can trap ice from both sides to improve the ice trapping efficiency and make the ice trapping process stable and reliable.
7. The vacuum pump and the main body are connected via an international standard KF quick coupling, which is simple and reliable.
8. The equipment features stable performance, easy operation, and low noise.

Technical indicators

1. Cold trap coil temperature: -65°C (no-load) ; optional -86°C (no-load); optional -110°C (no-load).
2. Ultimate vacuum: Below 2.7Pa (no-load).
3. Drying capacity:
 - 10: Three sample trays with a 200mm diameter for loading of 1130ml samples (material thickness: 12mm) or 180 (60*3) Φ22 vials
 - 12: Four sample trays with a 200mm diameter for loading of 1440ml samples (material thickness: 12mm) or 240 (60*4) Φ22 vials
 - 18: Six sample trays with a 200mm diameter for loading of 1920 ml samples (material thickness: 12mm) or 360 (60*6) Φ22 vials
4. Capping function: (AR Series only)
Three layers of sample trays with a reference diameter of 200mm can hold about 180 plugged vials.

Click the "Event Records" button to view the event records.

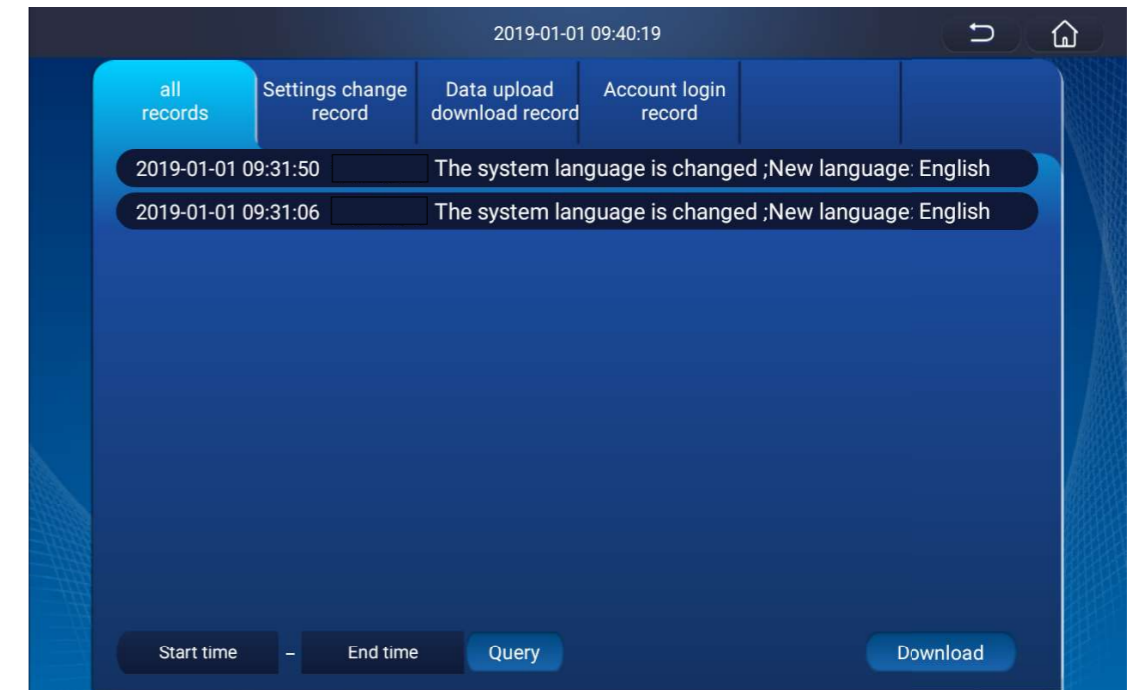

Notebook operations

Click the  button on the main interface to enter the notebook interface.

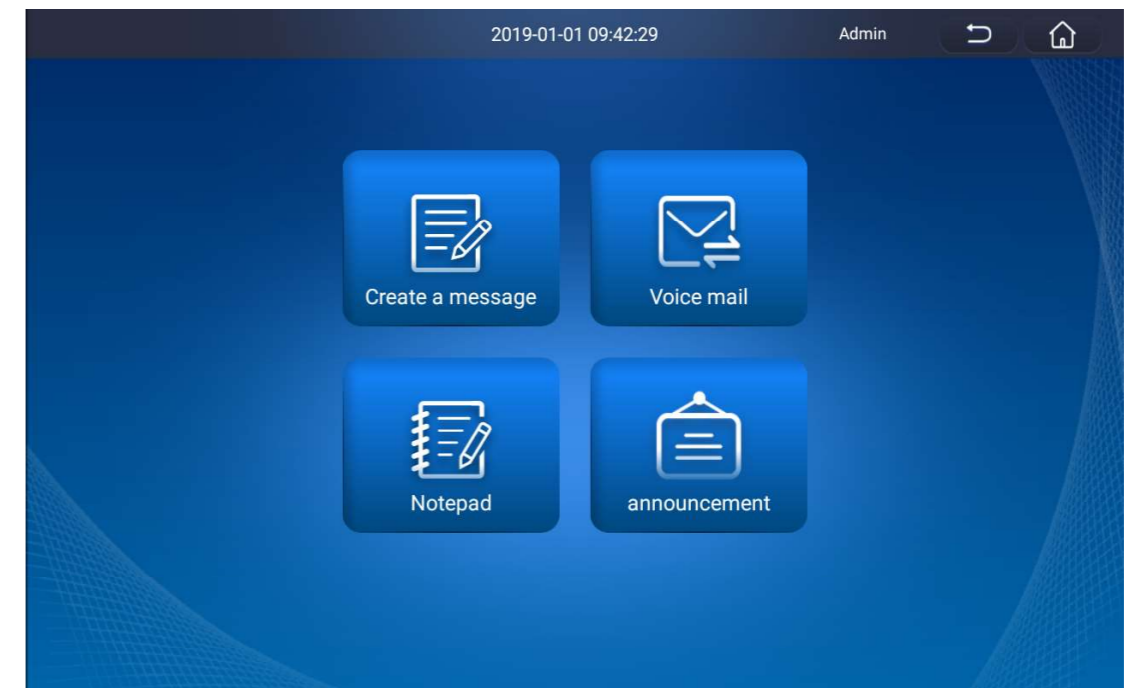

Query operations

Click the "Query" button on the main interface to enter the query interface and query the alarm records and event records.

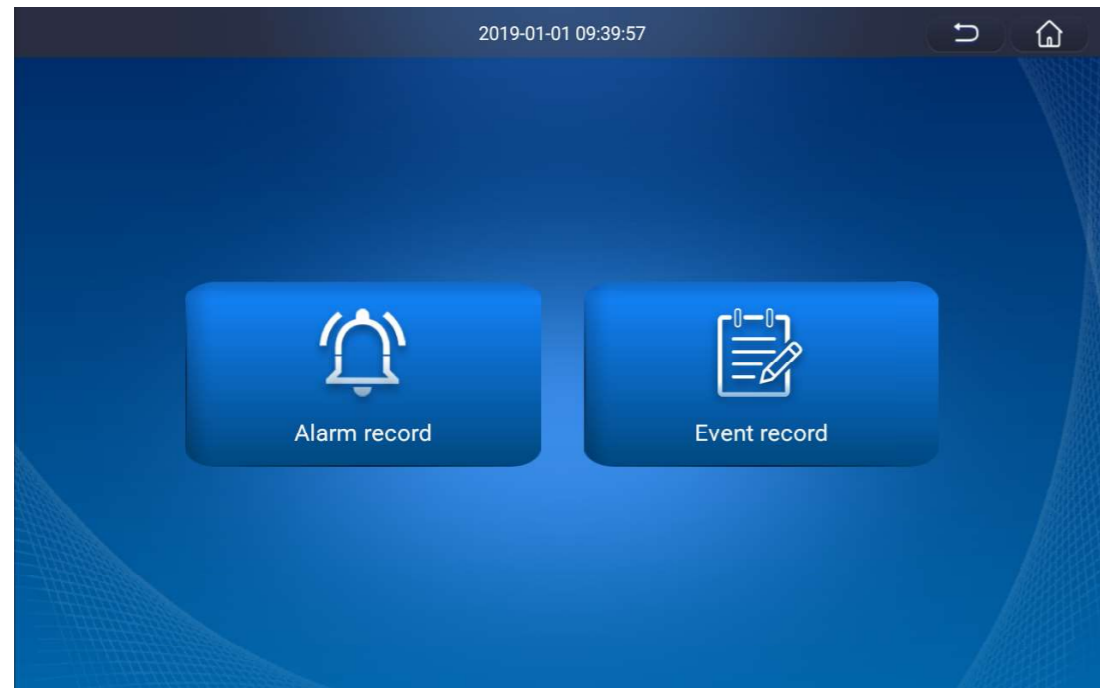

Click the "Alarm Records" button to view the history alarm records.

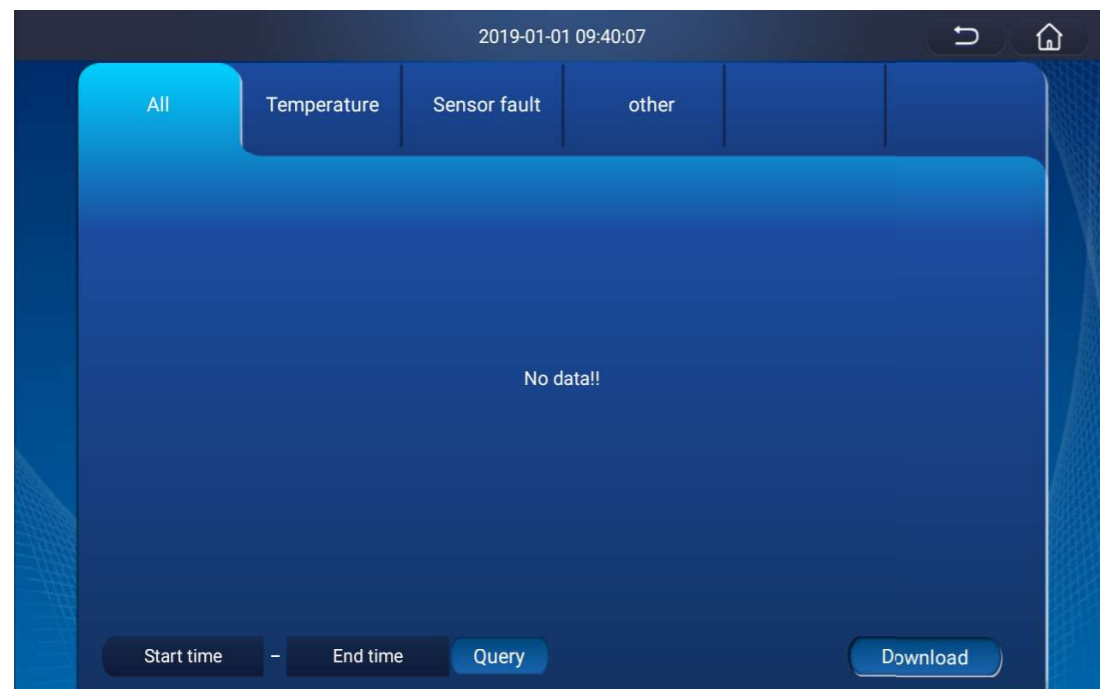

Operating conditions

1. Normal operating conditions:

- Ambient temperature: 10°C to 32°C.
- Relative humidity: $\leq 80\%$
- Power supply voltage: Single-phase, 220V $\pm 10\%$, 50Hz
- The operating environment shall be free of conductive dust, explosive and corrosive gases, and strong electromagnetic interference.

2. Transportation and storage conditions :

- Ambient temperature: -40°C~50°C;
- Relative humidity: $\leq 93\%$
- The storage environment should be well-ventilated and free from corrosive gases.

3. Safety Category I Type B.

Instrument installation and freeze-drying preparation

The structure and components of the dryer (Figure 1-1 A Structure of the A series main body)

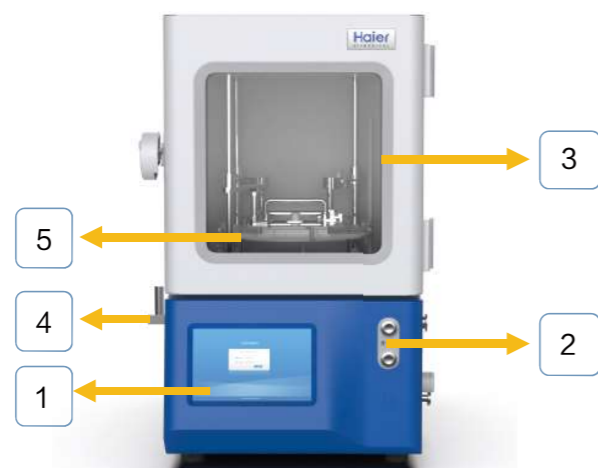

1. Display screen	2. Lifting and lowering switch	3. Drying chamber
4. Vacuum regulating valve	5. Material rack	6. Drying chamber door lock
7. Drying chamber door	8. Main power socket	9. Vacuum pump power socket
10. Vacuum pumping port(For vacuum pumps only)	11. Water drainage/pressure relief valve	

Click the "User Setting" button to enter the user setting interface, and then you can add users on this interface.

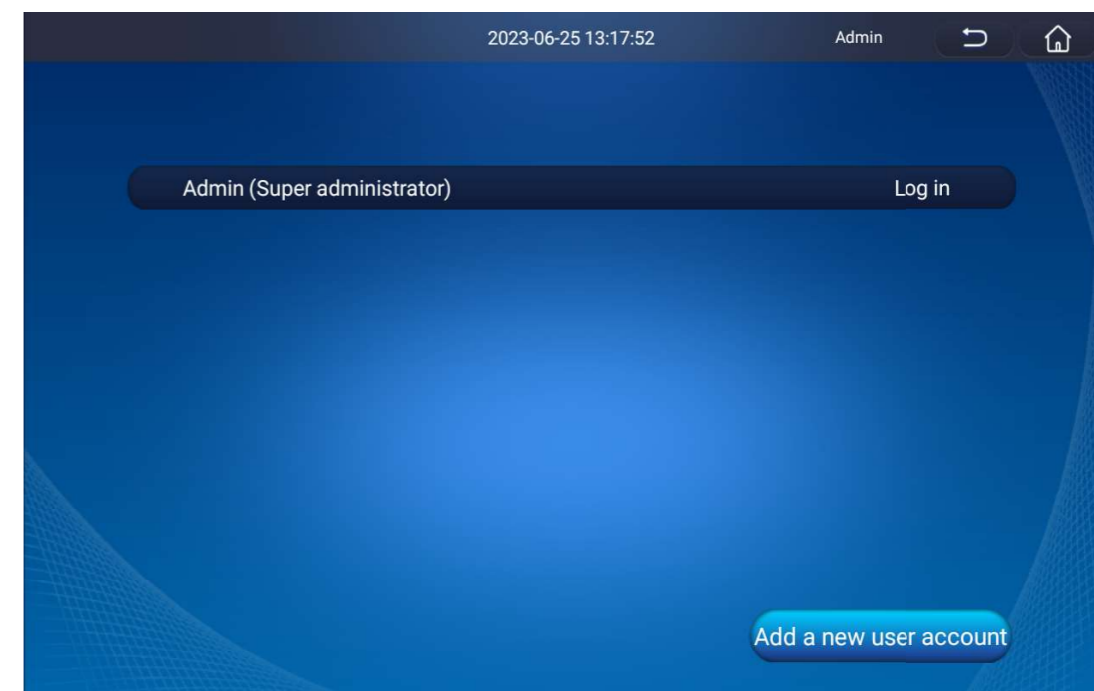

Click the "Device Information" button to enter the device information setting interface to view the device information. Click the "Firmware Upgrade" button to upgrade the software. Click the "Electronic Operation Manual Download" button to view and download the electronic operation manual.

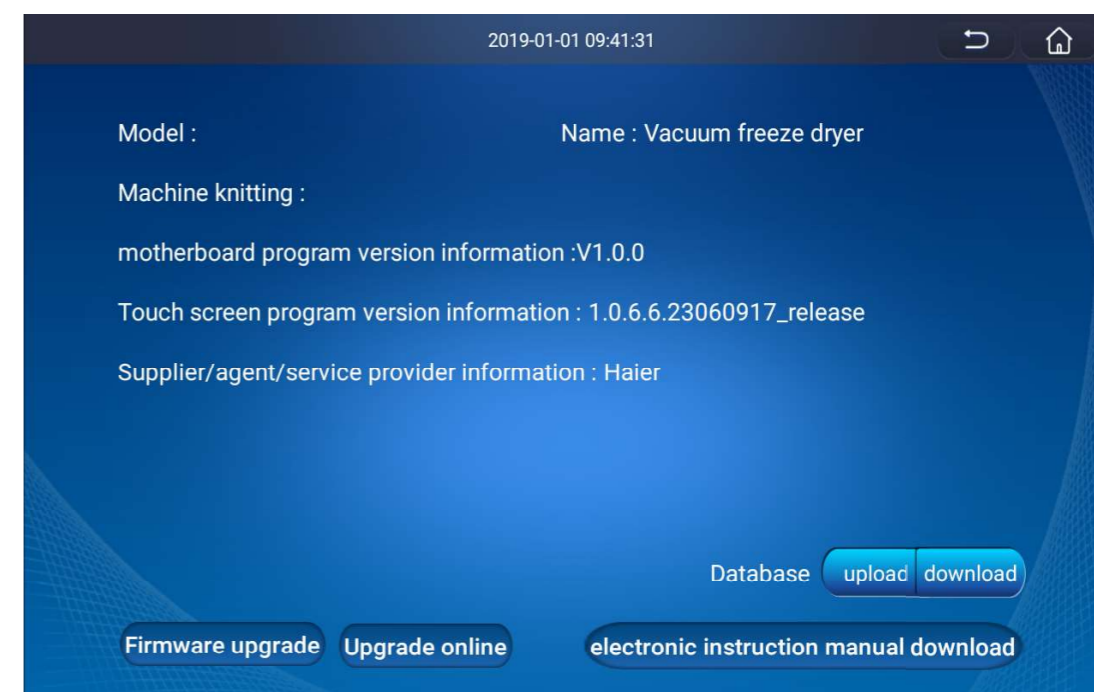

Click the "Basic Settings" button to enter the basic information setting interface. In this interface, you can select time setting, alarm volume, operation mode, etc. and conduct other operations.

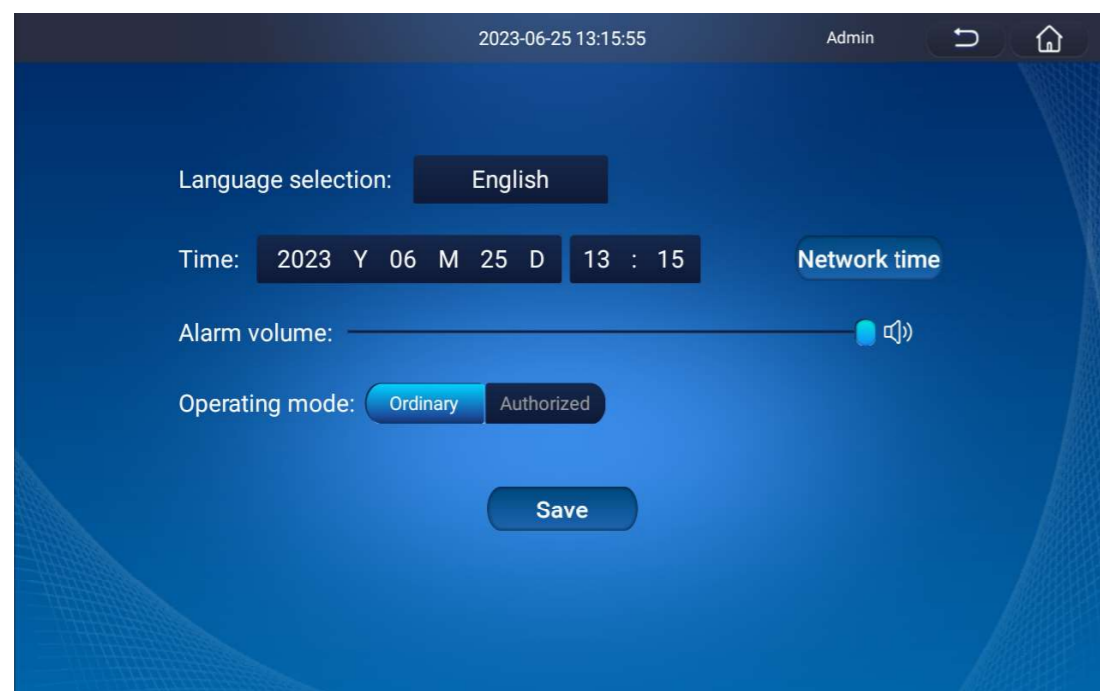

Click the "Network Setup" button to enter the network setting interface, and select the corresponding network.

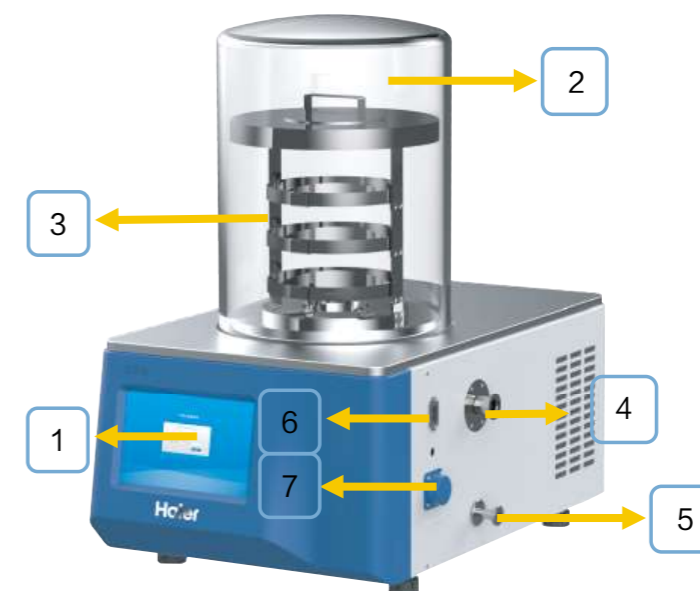
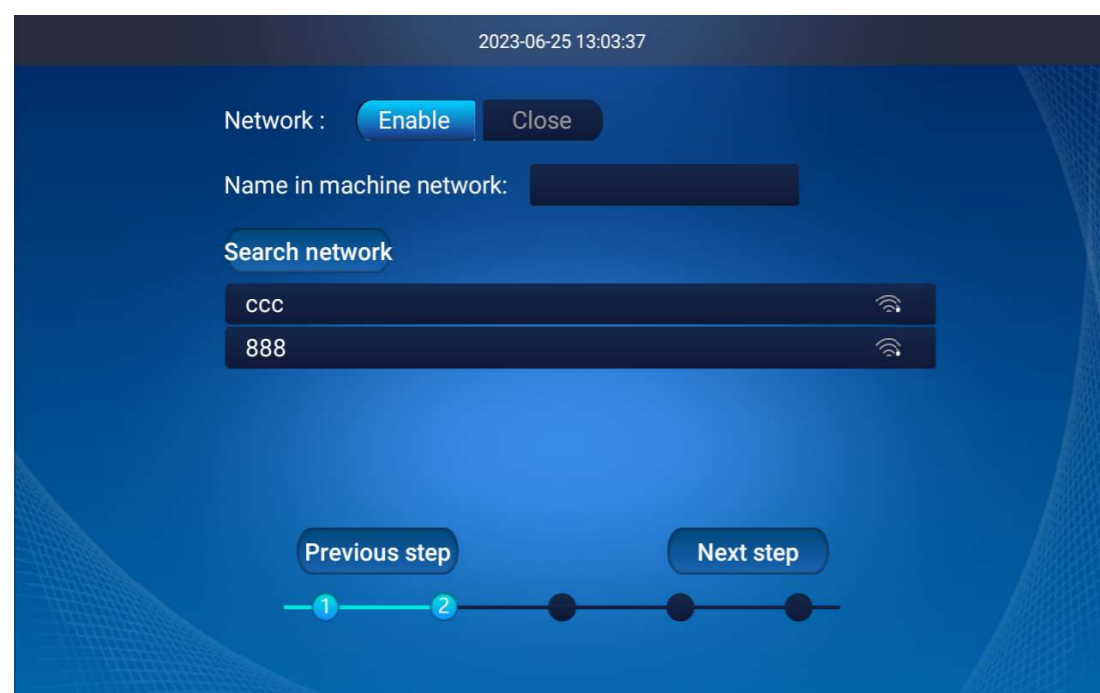

1. Display screen	2. Drying cylinder	3. Material rack
4. Vacuum pumping port	5. Drainage outlet	6. Main power socket
7. Vacuum pump power socket (For vacuum pumps only)		

Figure 1-2 Vacuum pump structure

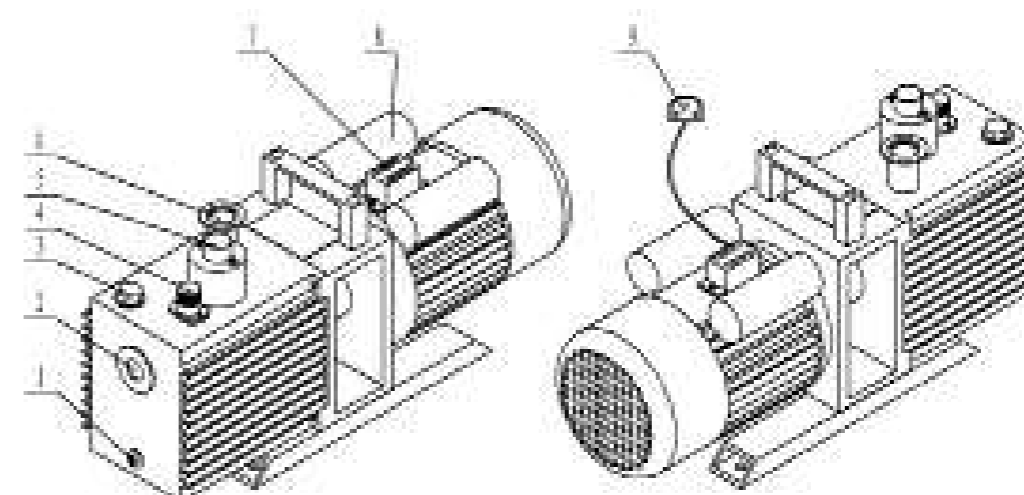

1. Oil drain	2. Oil level sight glass	3. Oil filling port
4. Gas ballast valve	5. Exhaust port	6. Air intake port
7. Wiring terminal	8. Capacitor	9. Vacuum pump power plug

Figure 1-3 Clamp structure

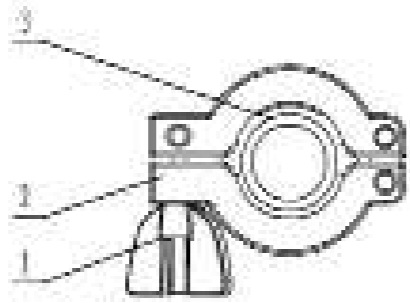

1. Swallowtail nut	2. Bracket	3. Seal ring
--------------------	------------	--------------

Equipment installation (Figure 1-4 Connection of the equipment)

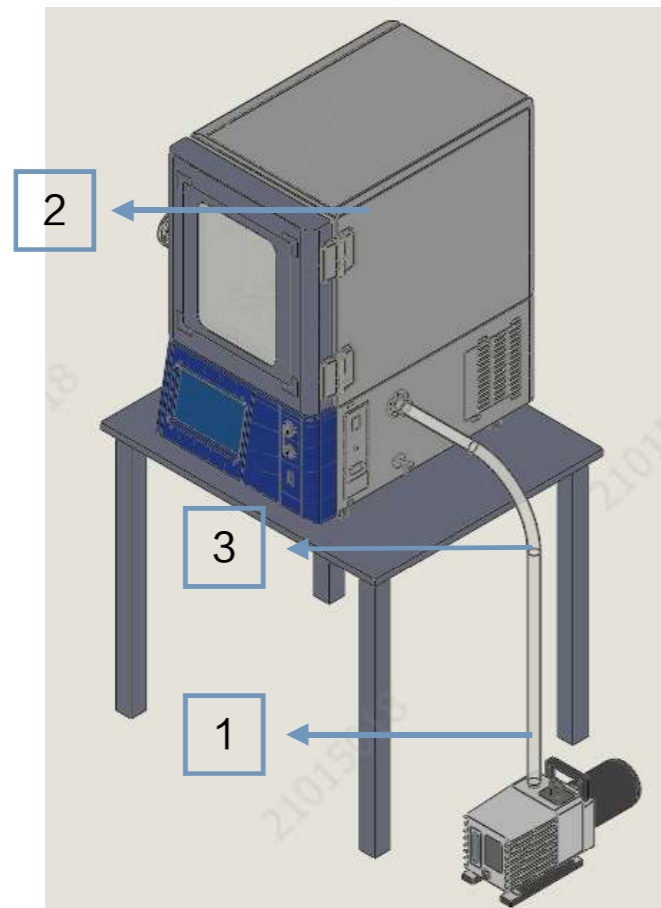

1. Vacuum pump	2. Freeze dryer	3. Vacuum pumping connection pipe
----------------	-----------------	-----------------------------------

Setting operations

Click the "Setting" button on the main interface to enter the setting interface.

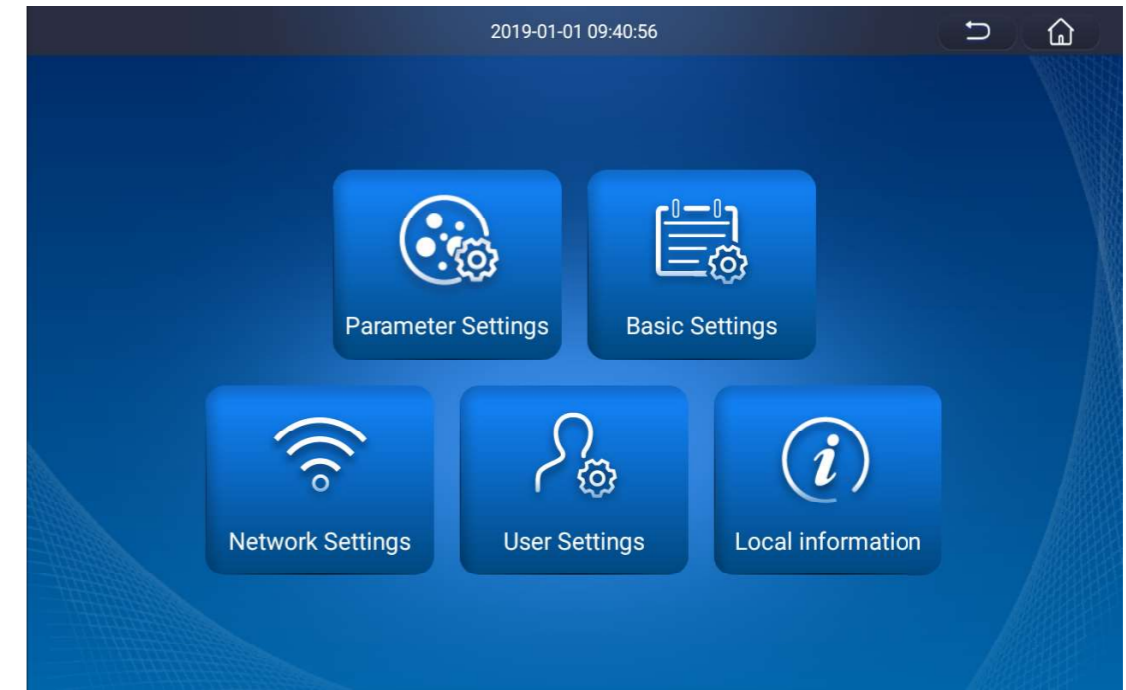

Click the "Parameter Setting" button to enter the parameter setting interface. In this interface, you can set the defrosting parameters, the vacuum pump oil replacement reminder, etc. and check the cumulative running time of the vacuum pump.

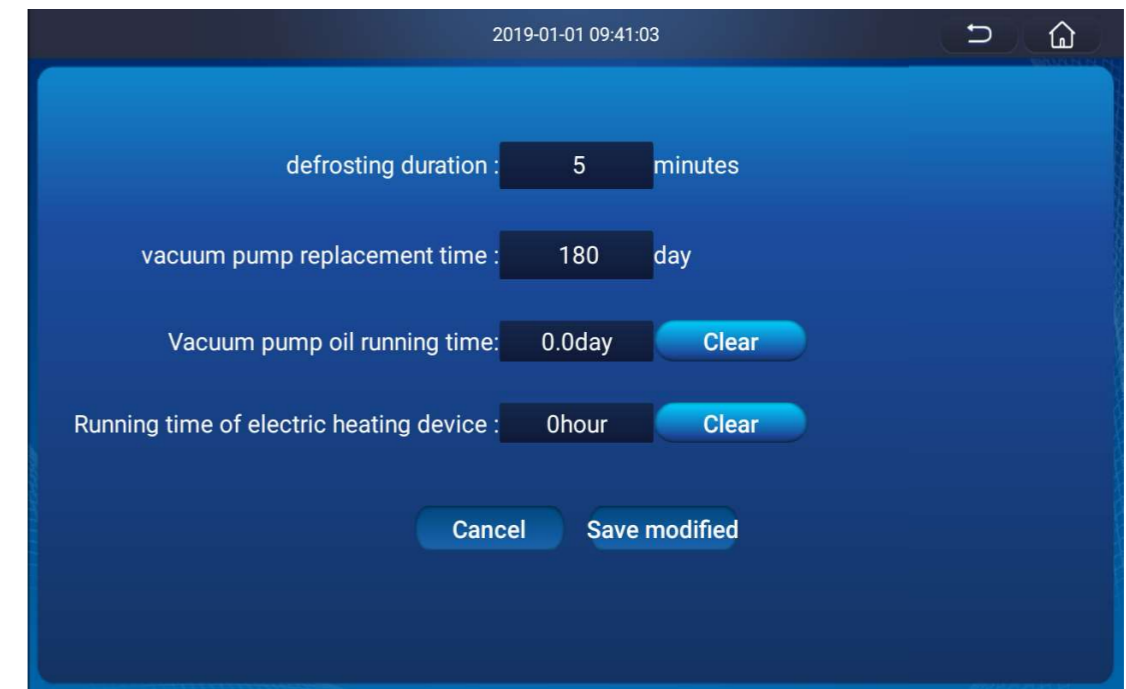

Viewing curves

1. Click the "Curve" button on the main interface to enter the curve viewing interface.
2. Click the real-time curve to view the current running curve, and click the historical curve to view the curves of previous experiments.
3. Select the curve name to delete or download (in this case, you will need to insert a FAT32 format USB flash drive) the corresponding curve.

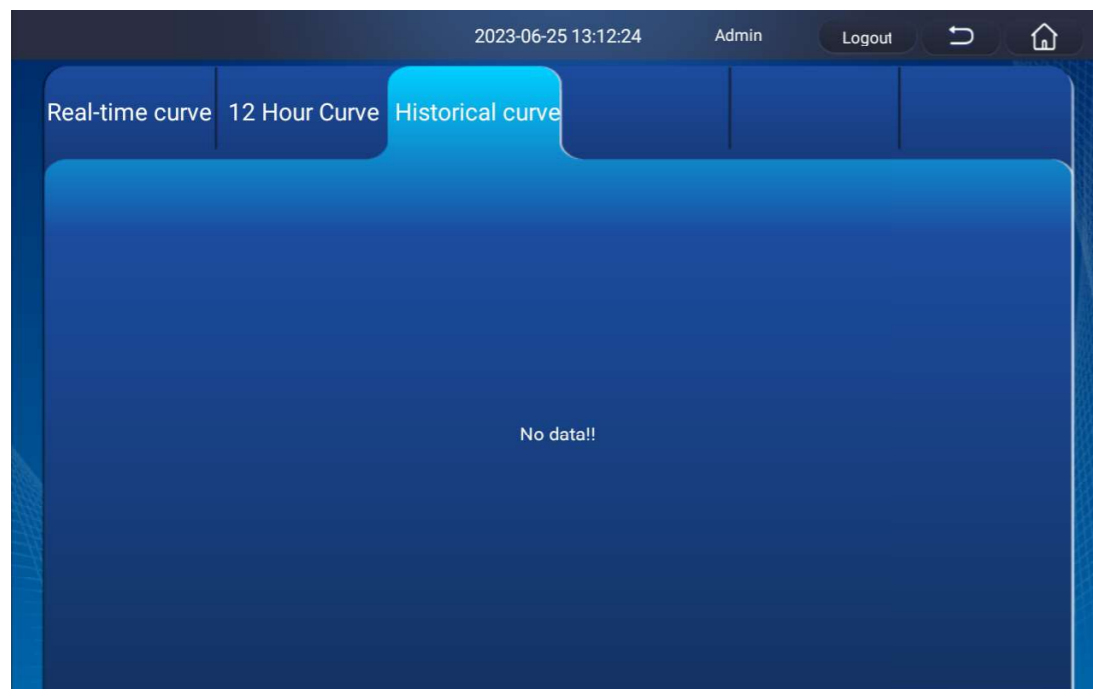
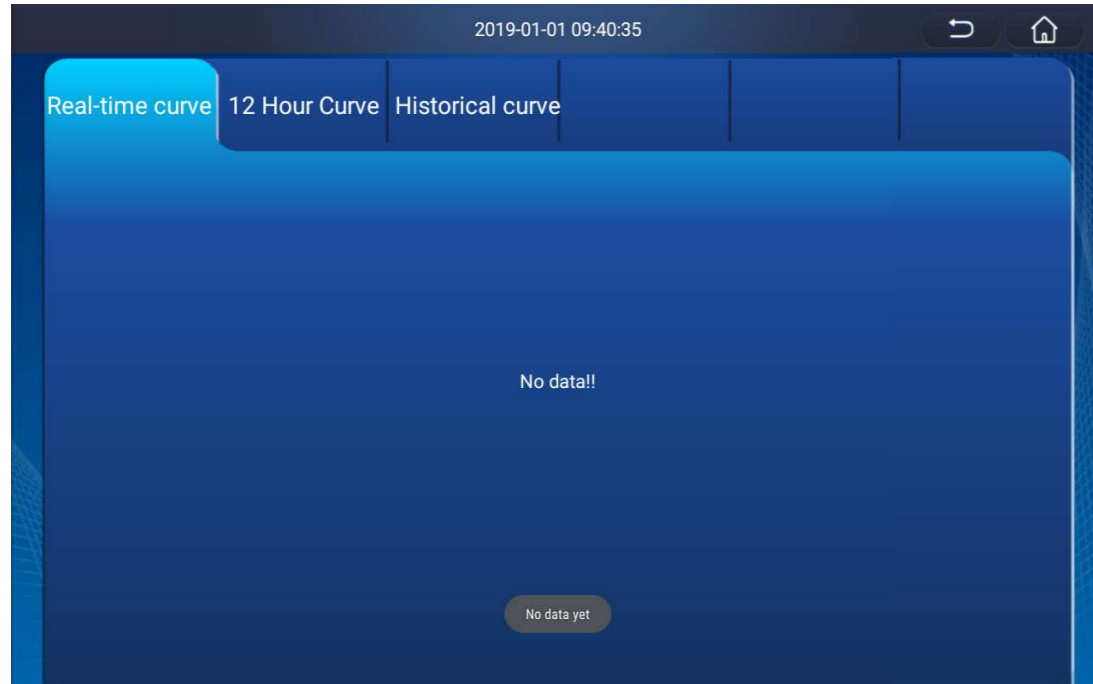

• Equipment installation procedures:

1. After unpacking, check whether the accessories are complete and undamaged according to the packing list.
2. Fill the vacuum pump with vacuum pump oil until the oil level arrives at the center of the sight glass (please select the matching pump oil (model: BS0-46) of the vacuum pump).
3. Connect the air intake port of the "vacuum pump" to the "vacuum pumping pipe" with a quick clamp, and connect the other end of the vacuum pumping pipe to the vacuum pumping port of the freeze dryer;
4. Connect the "vacuum pump power plug" to the dedicated power socket (220V, 50Hz);
5. Insert the power cord into the "main power supply" port of the main body, and connect the other end of the power cord to the dedicated 220V, 50Hz power supply (for safety reason, the power supply shall be equipped with a ground wire);
6. Test the various indicators of the equipment (the indicators include: vacuum degree $<5\text{Pa}$, cold trap temperature $<-65^{\circ}\text{C}$) to be normal in accordance with the procedures as set forth in the operation manual before putting the equipment into use.

• Precautions:

1. Ensure that there are no obstacles within 30cm of the air vents on the left and right sides of the host.
2. Make sure that the vacuum pump oil has been filled before starting the machine.

System settings

Power-on

- After the equipment is powered on for the first time, follow the steps to initialize the settings.

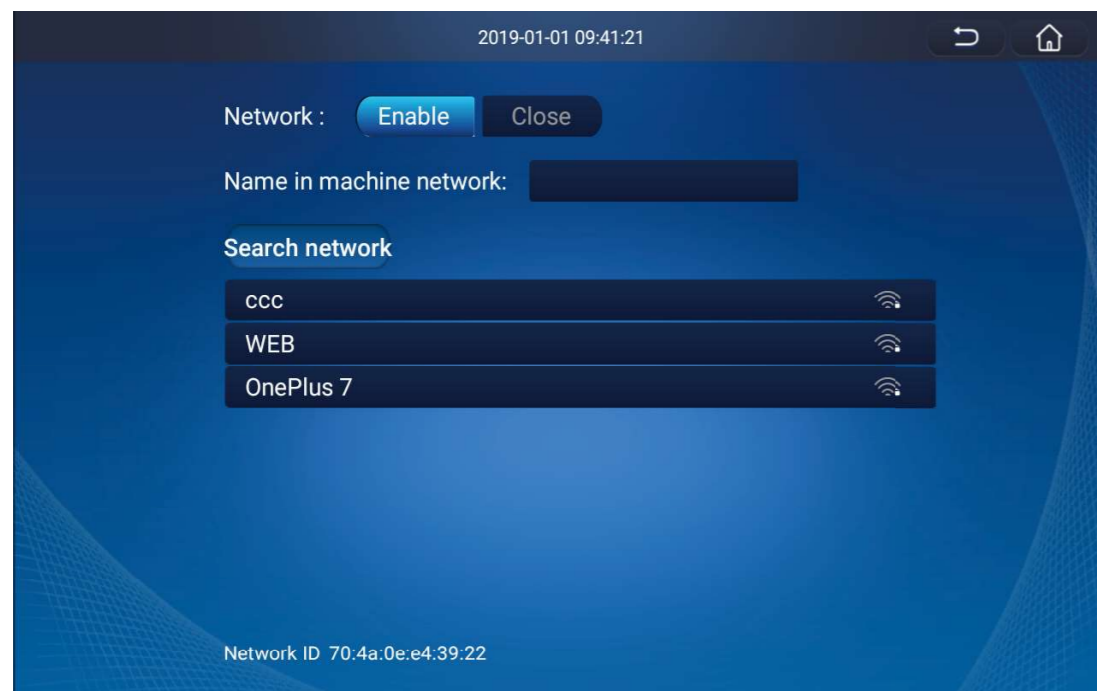
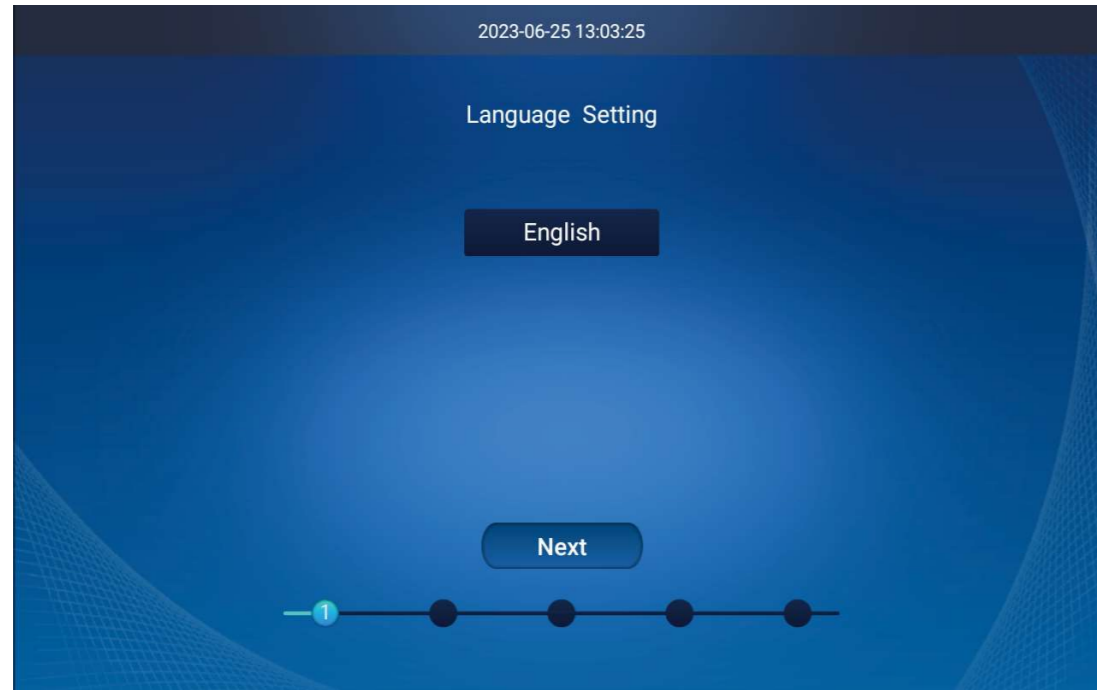

Automatic freeze-drying process

After the initialization, you will enter the main operation interface:

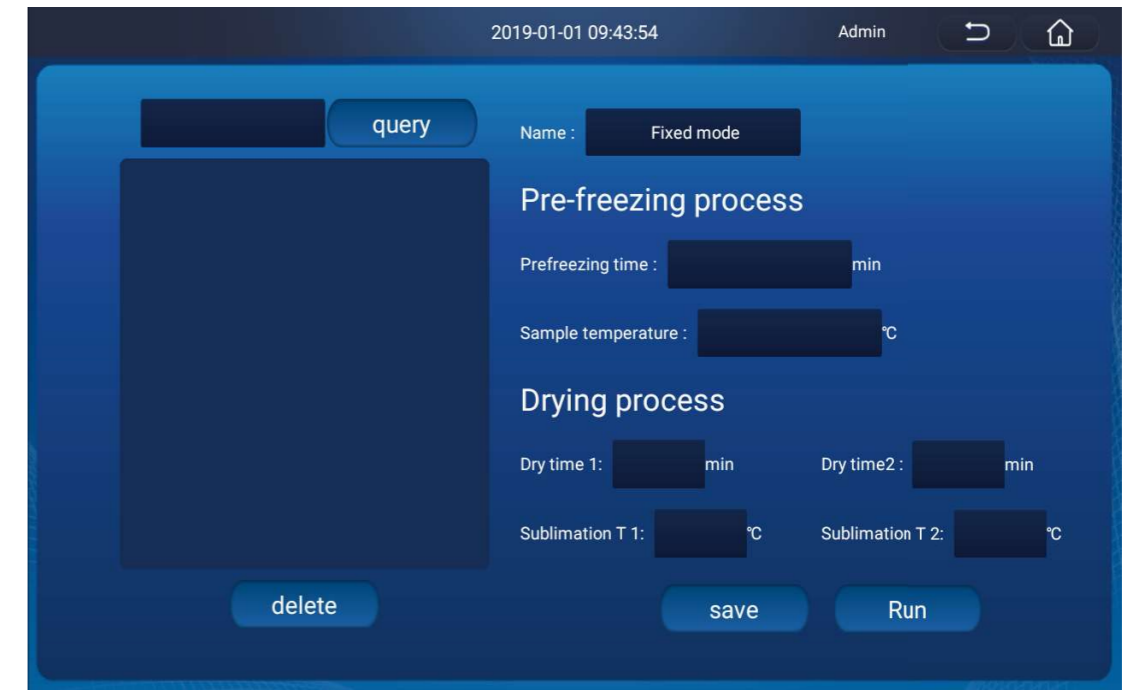



1. After putting the samples into the drying racks, close the door of the drying chamber (a sample temperature probe shall be placed in each material tray, and the probes shall be in fully contact with the materials so as to reduce the error between the sample temperature and the actual temperature), and check whether the various valves concerned are fully closed.
 2. Click the programming button  on the main interface to enter the programming interface.
 3. Set the program name, pre-freezing parameters, and drying parameters on the programming interface.
 4. After parameter editing, click the "Save" button, and select the corresponding program and click the "Run" button.
 5. After the program finishes running and the freeze drying is completed, open the vacuum regulating valve until the pressure becomes balanced, and then open the drying chamber door to take out the samples.
 6. Close the "vacuum regulating valve", and click the defrosting button on the screen to start defrosting; open the "drain (exhaust) valve" after defrosting, and wipe the equipment clean.
- (Note: To set the defrosting time, you can click the "Setup - Parameter Setting" buttons. After the set time is reached, the defrosting function will be stopped automatically. If the defrosting time is not set, it is 5min by default. The defrosting function can be operated only when the vacuum pump is closed)

• Manual pre-freezing process

General process of pre-freezing (if the sample quantity is small, it can be directly pre-frozen in the freeze-dryer; if the sample quantity is large, it shall be pre-frozen in the ultra-low-temperature freezer)

1. Press the motor lifting and lowering button (press and hold it for 1s) to lift the material rack into the drying chamber;
2. Put the materials into the material trays (liquid materials shall be directly poured into the material trays, while solid or bottled materials shall be evenly placed on the material trays);
3. Put the material trays into the drying racks, place a sample temperature probe into each material tray (the probes shall be in fully contact with the materials so as to reduce the error between the sample temperature and the actual temperature), and close the drying chamber door;
4. Press the motor lifting and lowering button (press and hold it for 1s) to lower the material rack into the cold trap;
5. Click the  button to start the cooling function and pre-freeze the materials until the temperature of all parts of the materials drops below the corresponding eutectic point. After about 1 hour, finish the pre-freezing, and prepare to enter the drying stage.

• Manual drying process:

1. After pre-freezing is finished, press the motor lifting and lowering button (press and hold it for 1s) to lift the material rack into the drying chamber;
2. Check whether the drying chamber door, drain valve, and vacuum regulating valve are completely closed.
3. Click  to turn on the vacuum pump for vacuum pumping of the samples. Then, the vacuum degree decreases, and the materials begin to be sublimated and dried. (Different samples have different requirements for vacuum degree which can be adjusted via the vacuum regulating valve);
4. For drying, click  to turn on the heating lamp function to assist in drying and increase the drying rate (For manual operations, the heating lamp turn-on conditions is that the sample temperature is below 25°C by default; when the sample temperature becomes higher than 25°C, the heating lamp will be turned off automatically);
5. After the drying is finished, close the "vacuum pump" before opening the "vacuum regulating valve", and open the door of the drying chamber until the air pressure is balanced to take away the samples.
6. Close the "vacuum regulating valve", and click the defrosting button on the screen to start defrosting; open the "drain valve" after defrosting, and wipe the equipment clean.
(Note: To set the defrosting time, you can click the "Setup - Parameter Setting" buttons. After the set time is reached, the defrosting function will be stopped automatically. If the defrosting time is not set, it is 5min by default. The defrosting function can be operated only when the vacuum pump is closed)
7. Cover the exhaust vent when the vacuum pump is not working to prevent dust from entering



Caution

- The refrigerator shall not be turned off during the whole drying process.
- The drying and pre-freezing time may vary depending on the material property differences.

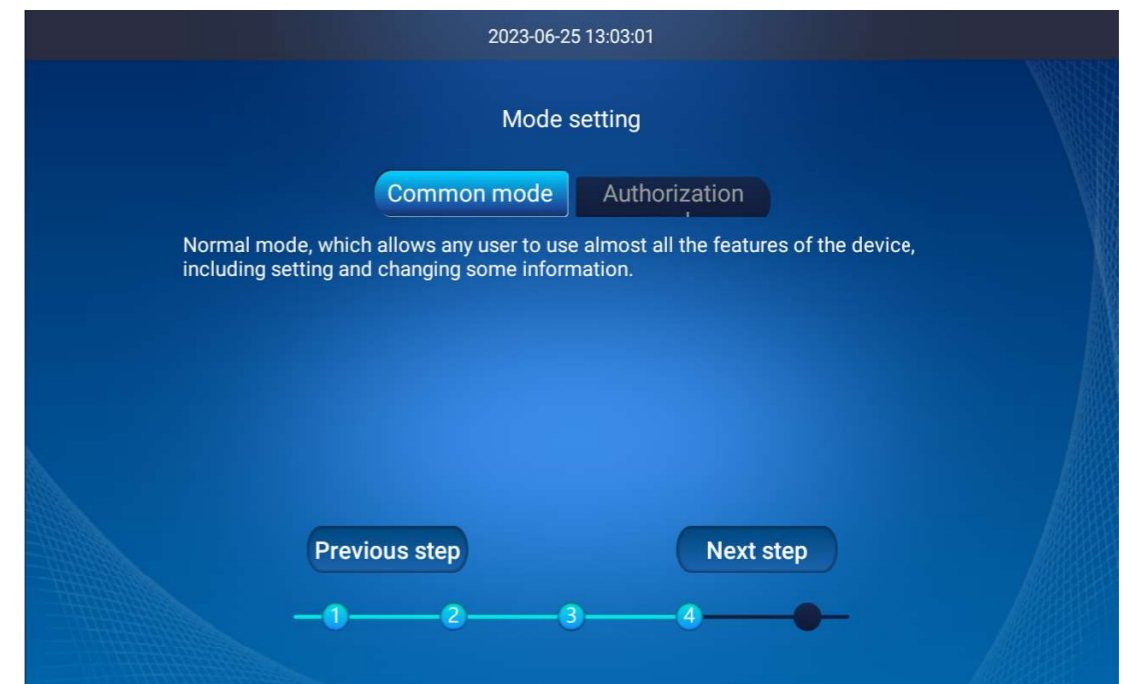
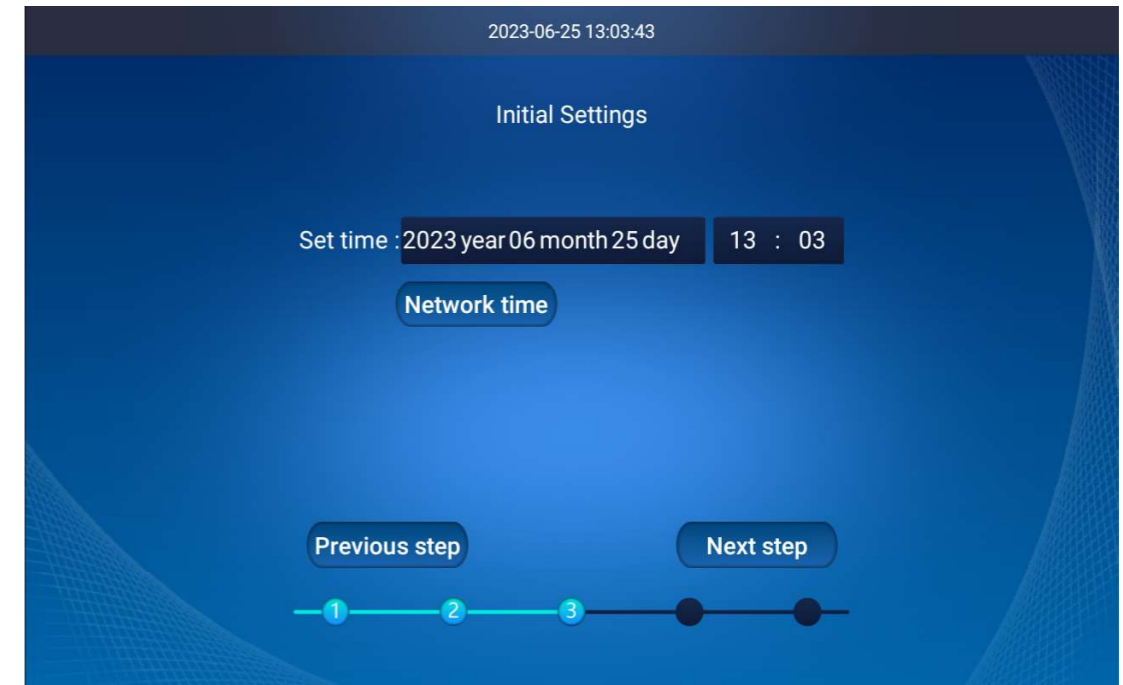

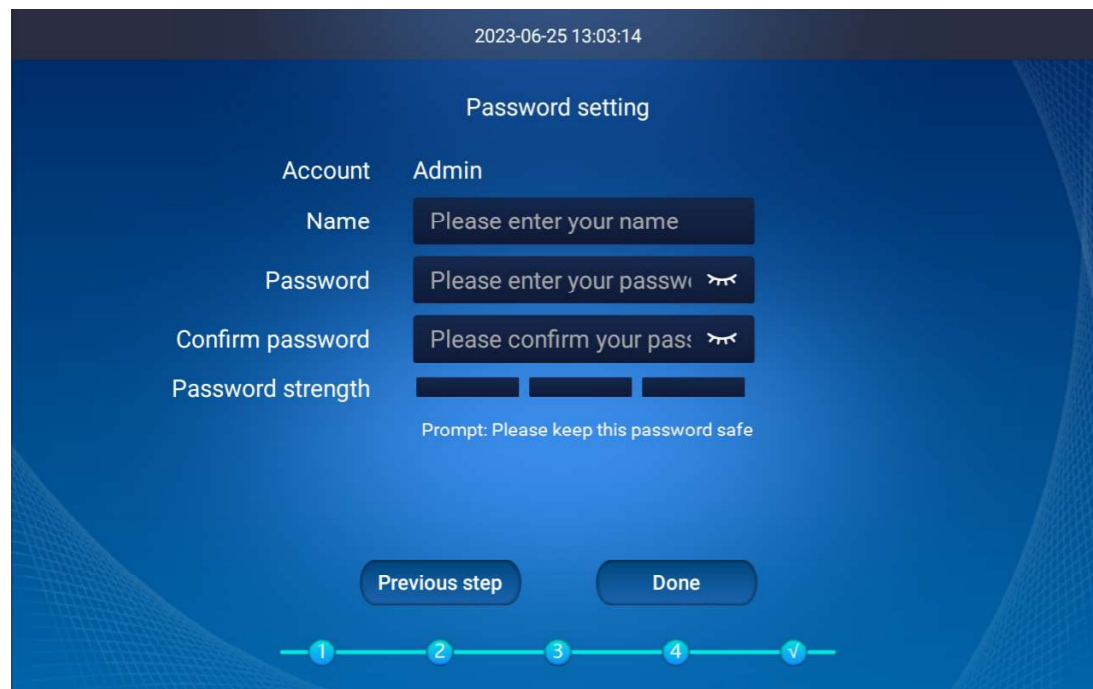
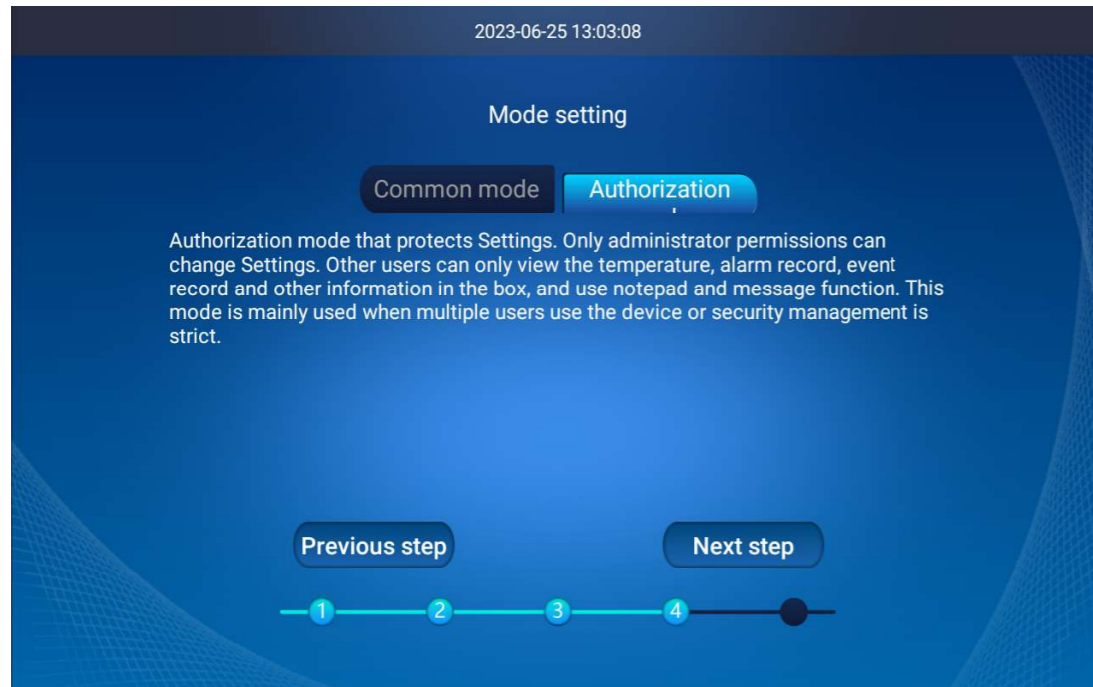

Manual pre-freezing process

After the initialization, you will enter the main operation interface:

A Series:



AR Series:

